

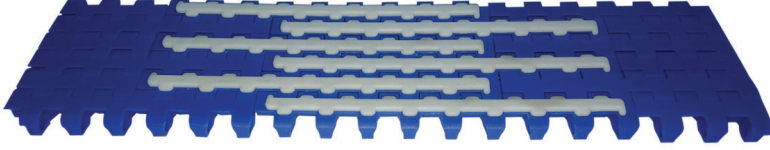

946 - 12,7 mm ÜSTÜ KAUCUKLU HASIR BANT

 DİŞLİ : 388



Stok Kod (Stock Code)	P	RM	Malzeme/Material	L	PIN	Bant Dayanımı Chain Strength (N/m)	Kg / m ²	
946 MS2 K01	12,7	-	Polipropilen Polypropylene	254,4	PP	10000	4,5	m

Hatve	12.7 mm
Bant Kalınlığı	9,80 mm
Açıklık Oranı (%)	Kapalı yüzey (%0)
Bakla Genişliği	254,4 mm /100mm/ 50mm (bant genişliği aşağıdadır)
Genişlik ölçülendirme	16-17mm
Renk	Beyaz - Mavi - Gri (standart malzeme için)
Temizlenebilirlik	Orta (FDA gıdaya uygunluk)
PIM Çapı	4mm

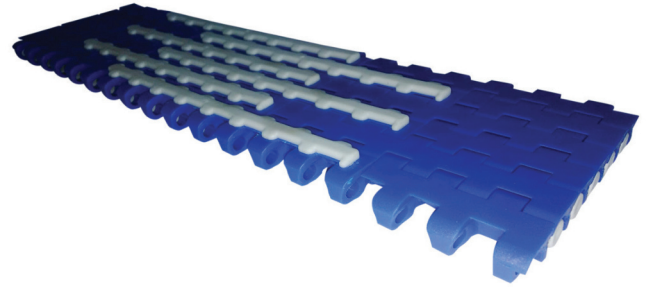
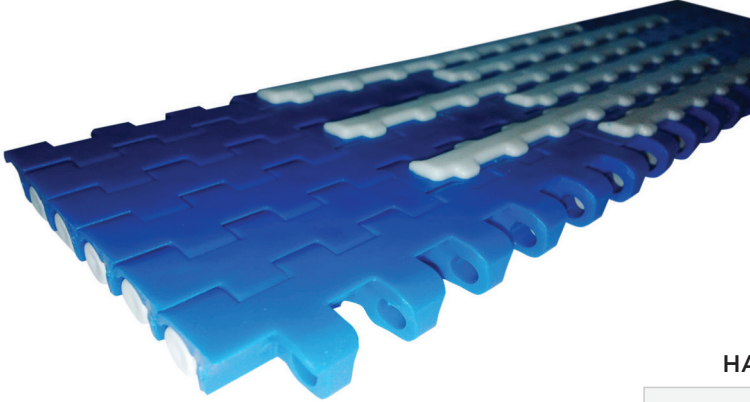

HASIR BANT STANDART MALZEME

Polipropilen (PP)	+1	+110
Poliasetal (POM)	-40	+90
Polietilen (PE)	-60	+100

388 HASIR BANT DİŞLİSİ

 BANT : 945 - 946

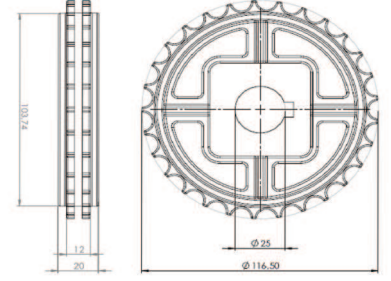
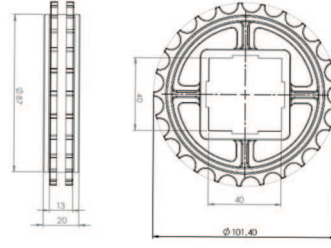

STN Stok Kod [Stock Code]	DF	DE	DP	Kalınlık Thicknes	Z-İmalat Şekli [Manufacture]	Kg
388 D25 T24	ø25	97,20	87,20	20	24-Kalıplı/Molding	0,2
388 D30 T24	ø30	97,20	87,20	20	24-Kalıplı/Molding	0,2
388 D35 T24	ø35	97,20	87,20	20	24-Talaşlı/Sawdust	0,2
388 D40 T24	40x40	97,20	87,20	20	24-Kalıplı/Molding	0,2
388 D25 T25	ø25	101,40	91,40	20	25-Kalıplı/Molding	0,25
388 D30 T25	ø30	101,40	91,40	20	25-Kalıplı/Molding	0,25
388 D35 T25	ø35	101,40	91,40	20	25-Talaşlı/Sawdust	0,25
388 D40 T25	40x40	101,40	91,40	20	25-Kalıplı/Molding	0,25
388 D25 T29	ø25	117,50	107,50	20	29-Kalıplı/Molding	0,3
388 D30 T29	ø30	117,50	107,50	20	29-Kalıplı/Molding	0,3
388 D35 T29	ø35	117,50	107,50	20	29-Talaşlı/Sawdust	0,3
388 D40 T29	40x40	117,50	107,50	20	29-Kalıplı/Molding	0,3
388 D25 T38	ø25	153,70	143,70	20	38-Kalıplı/Molding	0,35
388 D30 T38	ø30	153,70	143,70	20	38-Kalıplı/Molding	0,35
388 D35 T38	ø35	153,70	143,70	20	38-Talaşlı/Sawdust	0,35
388 D40 T38	40x40	153,70	143,70	20	38-Kalıplı/Molding	0,35

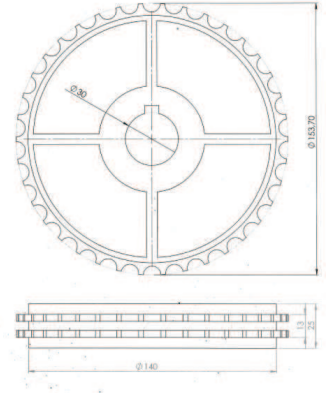
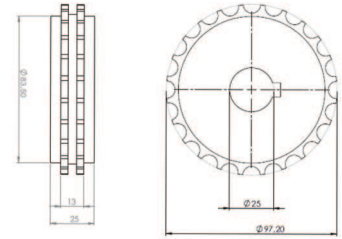

12.7 HASIRBAND DİŞLİ Z.38
Göbek; Ø25mm Ø30mm 40.40 kare



388.Grup Görseli B / Z38 / Z24 / Z29 / Z25

