

938- 25,4 YAN KULAK

 BANT : 927

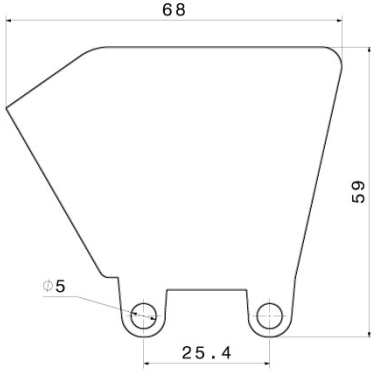

Stok Kod (Stock Code)	P	Renk (Color)	H	Malzeme (Material)	PIN
938 B01 K01	25,4	Beyaz/White (B)	50	Polipropilen Polypropylene	PP
938 B02 K01	25,4	Beyaz/White (B)	50	Poliasetal Polyacetal	PA

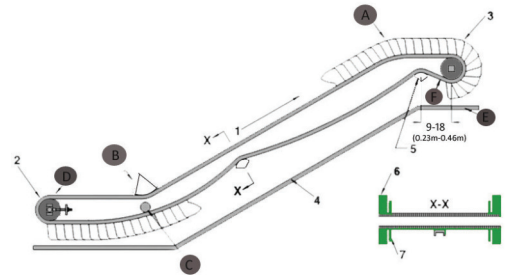
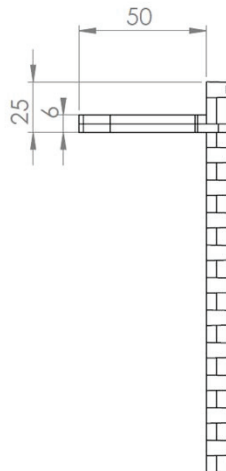
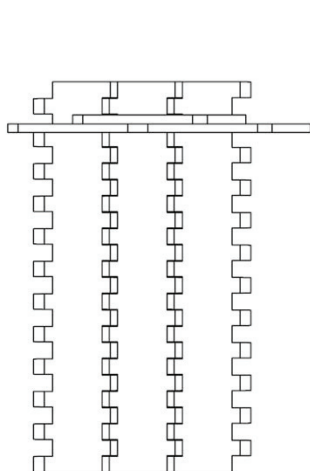
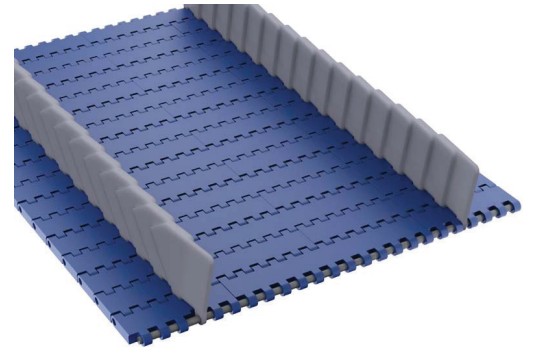
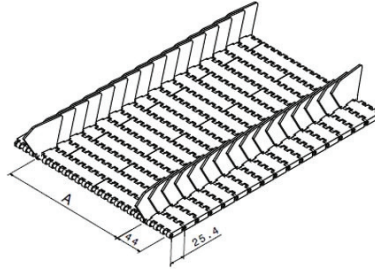
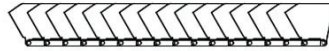
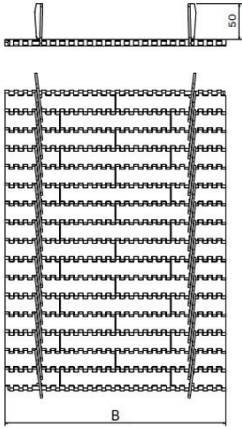

927- 25,4 KİLİTLİ DÜZ HASIR BANT

AKSESUARLAR

939-25,4 HASIR TAŞIMA BANT GÖTÜRÜCÜ
947-25,4 KİLİTLİ KAUÇUK GÖTÜRÜCÜ HASIR BANT
937-25,4 KİLİTLİ TARAKLI GÖTÜRÜCÜ BANT
938-25,4 YAN KULAK

DİŞLİ

381- HASIR BANT TAHRİK DİŞLİSİ

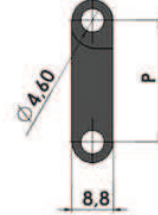
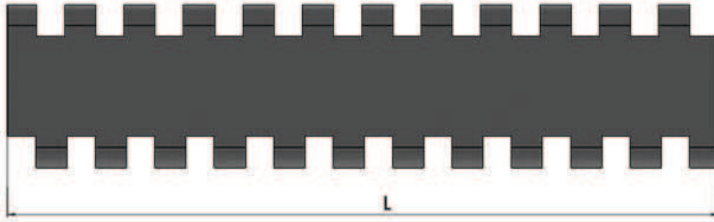

Stok Kod (Stock Code)	P	Renk (Color)	L	Malzeme/Material	PIN	Bant Dayanımı Chain Strength (N/m)	Kg / m ²	
927 B01 K01	25,4	Beyaz / White (B)	152,4	Polipropilen Polypropylene	PP	21160	2,600	m
927 B02 K01	25,4	Beyaz / White (B)	152,4	Poliasetal Polyacetal	PA	20400	3,900	m
927 M01 K01	25,4	Mavi / Blue (M)	152,4	Polipropilen Polypropylene	PP	35200	2,600	m
927 M02 K01	25,4	Mavi / Blue (M)	152,4	Poliasetal Polyacetal	PA	34100	3,900	m

ALHAN® düzgün doğrusal yüzeyi kapalı bantlarımız istediğiniz ölçülerde ve (modüler) hasır bandın hasar gördüğü durumunda kolay değiştirilir kilitli sistemine sahiptir . Çeşitli sektörlerde uyumluluk gösterir - 60 +100 (Özel çalışma statusu gerektiren yerler için farklı malzemeler ile uygulamalar yapılabilmektedir.) Uzun konveyör hatları tercihlerinizde ALHAN 25.4mm hatveli (1 inç) hasır bantlarımız yüksek dirençli özelliklerinden dolayı fazla gözetim gerektirmeyen durumlarda tercih sebebidir . Sağlıklı nakil için ALHAN (modüler) Hasır Bant uzun ömürlüdür, daha az bakım gerektirerek enerji tasarrufu sağlar.

Model 927 (modüler) Hasır bandın yüzeyi düz ve pürüzsüz olup, temiz yapısıyla gıda sektörüne uygundur. FDA Gıdaya uygun belge onayına sahiptir.

25.4 mm hatveli (1 inç) (modüler) hasır bandın kullandığı endüstri alanları:

- Gıda Sektörü
- Otomotiv Sektörü
- Et Ürünleri Sektörü
- İlaç Sektörü
- İçecek Su ve Süt Sektörü
- Sebze ve Meyve Sektörü
- Konserveler Sektörü
- Deniz Ürünleri Sektörü
- Şekerleme Sektörü
- Paketleme Sektörü
- Oluklu Mukavva Sektörü
- Unlu Mamüller

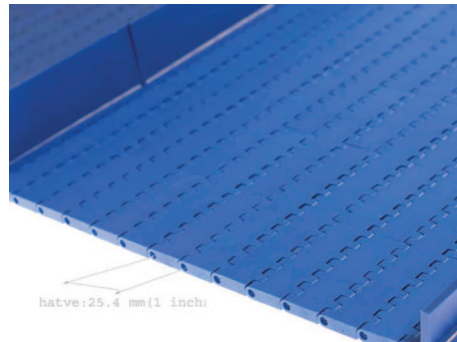

927- 25,4 KİLİTLİ DÜZ HASIR BANT

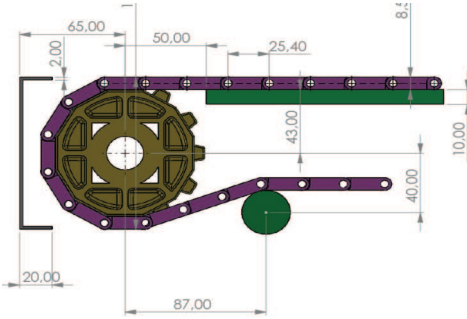
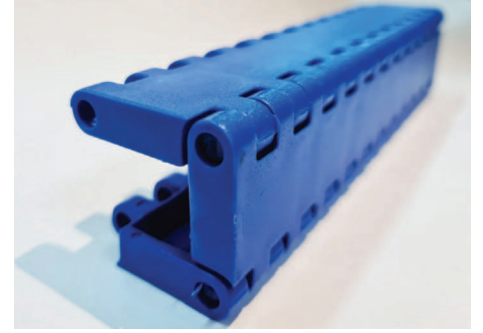
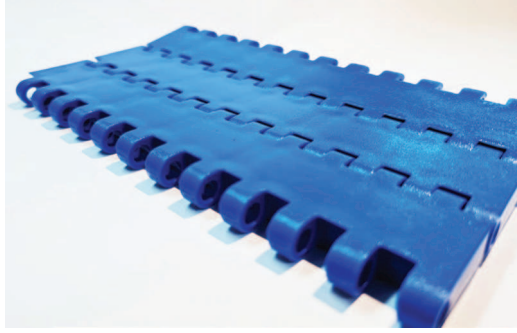

25.4 HASIR BANT DİŞLİ Z.12

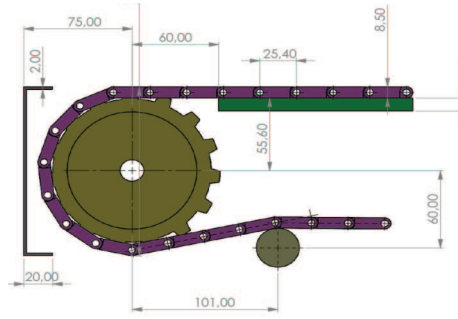

25.4 HASIR BANT DİŞLİ Z.15

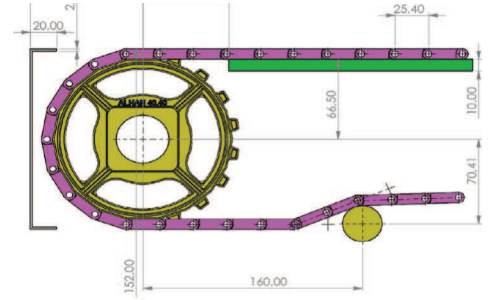

25.4 HASIR BANT DİŞLİ Z.18

Hatve	25.4 mm
Bant Kalınlığı	8,8 mm
Açıklık Oranı (%)	Açık yüzey
Bakla Genişliği	152,4 mm
Genişlik ölçülendirme	25 mm
Renk	beyaz mavi gri (standart malzeme için)
Temizlenebilirlik	Orta (FDA gıdaya uygunluk)
PIM Çapı	4,6 mm
Diş üstü yarı çap	Dişli boyutuna göre değişmektedir
Götürücü	mevcut (Yükseklik: 25/50/75/100 mm)
Yan boşluk uygulaması	mevcut (özel boşluklu ölçülere tabidir)
Yan kulak	mevcut Yükseklik: 50 mm

HASIR BANT STANDART MALZEME

Polipropilen (PP)	+1	+110
Poliasetal (POM)	-40	+90
Polietilen (PE)	-60	+100

